

# appetiser.

2021 Media Kit



# what is **appetiser?**



**appetiser.** is an industry magazine that has been created to further position Bidfood and its suppliers as leaders and innovators of the foodservice industry. This flagship magazine offers readers expert knowledge on all things food, as well as showcasing the latest trends and new products to inspire chefs to re-define their menus. **appetiser.** provides a unique way to engage with customers and, therefore, is an effective indirect sales and brand-building opportunity.



# our audience



**appetiser.** is targeted at all existing and potential customers ordering from the vast array of brands in the foodservice industry. These customers can be based in restaurants, pubs, clubs, hotels, cafes and more. **appetiser.** is distributed directly to Bidfood's national customer base via the network of reps across the 50+ foodservice, meat and liquor branches. In addition, copies are direct mailed to select industry professionals, including well-respected chefs and industry bodies/associations. **appetiser.** is also available to view online at [appetisermagazine.com.au](http://appetisermagazine.com.au), digitally via EDM (Electronic Direct Mail) and is promoted on myBidfood, [bidfood.com.au](http://bidfood.com.au) and our Bidfood social channels.



**5000+** likes  
**6000+** followers



**800+** followers



**3000+** followers



**5000+** followers

## Seasonal issues

Over **50,000** customers

**EDM campaigns** resulting in a **34.5% open rate** (in comparison to the foodservice industry average of 24.71%) and a **click rate of 15.82%** (in comparison to the industry average of 2.98%) from **30,000+ contacts in our data base**











Average of **20,000 active users** on **bidfood.com.au** per week, and a **growing social media following**

# rates and opportunities



## Advertisement spaces throughout the magazine

### Positioning & Rates (excluding GST)

	Inside Front Cover	Full Page	220mm x 274mm
	Page 2	Full Page - preceding credits/contents page	220mm x 274mm
	Page 4	Full Page - adjacent 'word on the street'	220mm x 274mm
	Page 12	Full Page - adjacent 'breaking down the dish'	220mm x 274mm
	Page 16	Full Page - preceding feature article	220mm x 274mm
	Page 25	Third Page (Landscape) - cooking masterclass feature	220mm x 92mm
	Page 26	Full Page - preceding 'the catch' (all about seafood section)	220mm x 274mm
	Page 32	Full Page - preceding filler article	220mm x 274mm
	Page 35	Full Page - adjacent filler article	220mm x 274mm
	Inside Back Cover	Full Page	220mm x 274mm
	Back Cover	Full Page	220mm x 274mm

\* Limited spots available, with only 4 editions per year

### Specifications

- Artwork must be supplied as high resolution (300dpi) PDF
- Allow minimum 3mm bleed on all edges. Trim marks are preferred
- For full page adverts allow minimum 15mm exclusion zone inside the trim area. No critical information (eg. logos, text) should be placed within this area. (Example opposite)
- Spot (PMS) colours should not be used (eg. special logo colours). Convert all colours to CMYK (if we convert them for you, the results may not be as you expect)

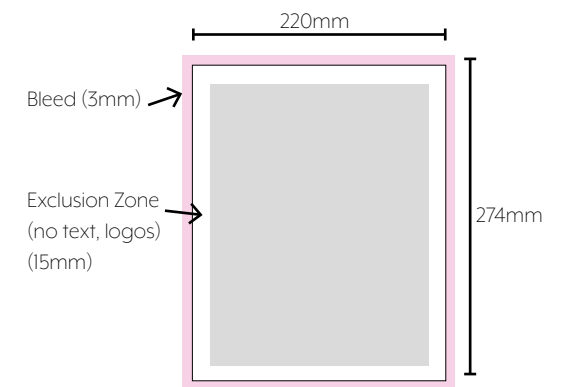

# rates and opportunities



## Content Requirements

- Advertisements must be in keeping with the style of the publication and offer serving suggestions/inspiration to customers, or brand positioning themes
- Advertisements cannot be overtly promotional in style or contain line listing tables
- Artwork must have minimal copy. It is our preference that only food/plate/hero shots are used for all advertising. If the artwork is for brand awareness or positioning, pack shots may be considered
- Only Bidfood product codes to be used. Wording should be 'Bidfood Code:' rather than 'Product Code:'
- Artwork must not contain supplier's phone numbers or order email address. In addition, references such as 'see suppliers representative' are not permitted. Website addresses can be included
- Artwork can contain the following wording at the bottom of the page: 'To place an order, or for more information, contact your local Bidfood branch'
- For the digital flipbook, please provide a URL or Youtube/Vimeo link for video (if applicable)

**Artwork approval is at the discretion of Bidfood National Marketing**

# deadlines



ISSUE	BOOKING	MATERIAL	RELEASE
March - May 2021	13/01/2021	10/02/2021	15/03/2021
June - August 2021	14/04/2021	12/05/2021	14/06/2021
September - November 2021	14/07/2021	11/08/2021	13/09/2021
December 2021 - February 2022	13/10/2021	10/11/2021	13/12/2021

All bookings are to be made via the NatPRO Supplier Portal:

**bidfood.com.au > Suppliers & Partners > Supplier Portal Log In**

For material submissions, please refer to corresponding specifications

For more information, please contact **marketing@bidfood.com.au** or phone **(07) 3823 8796**